

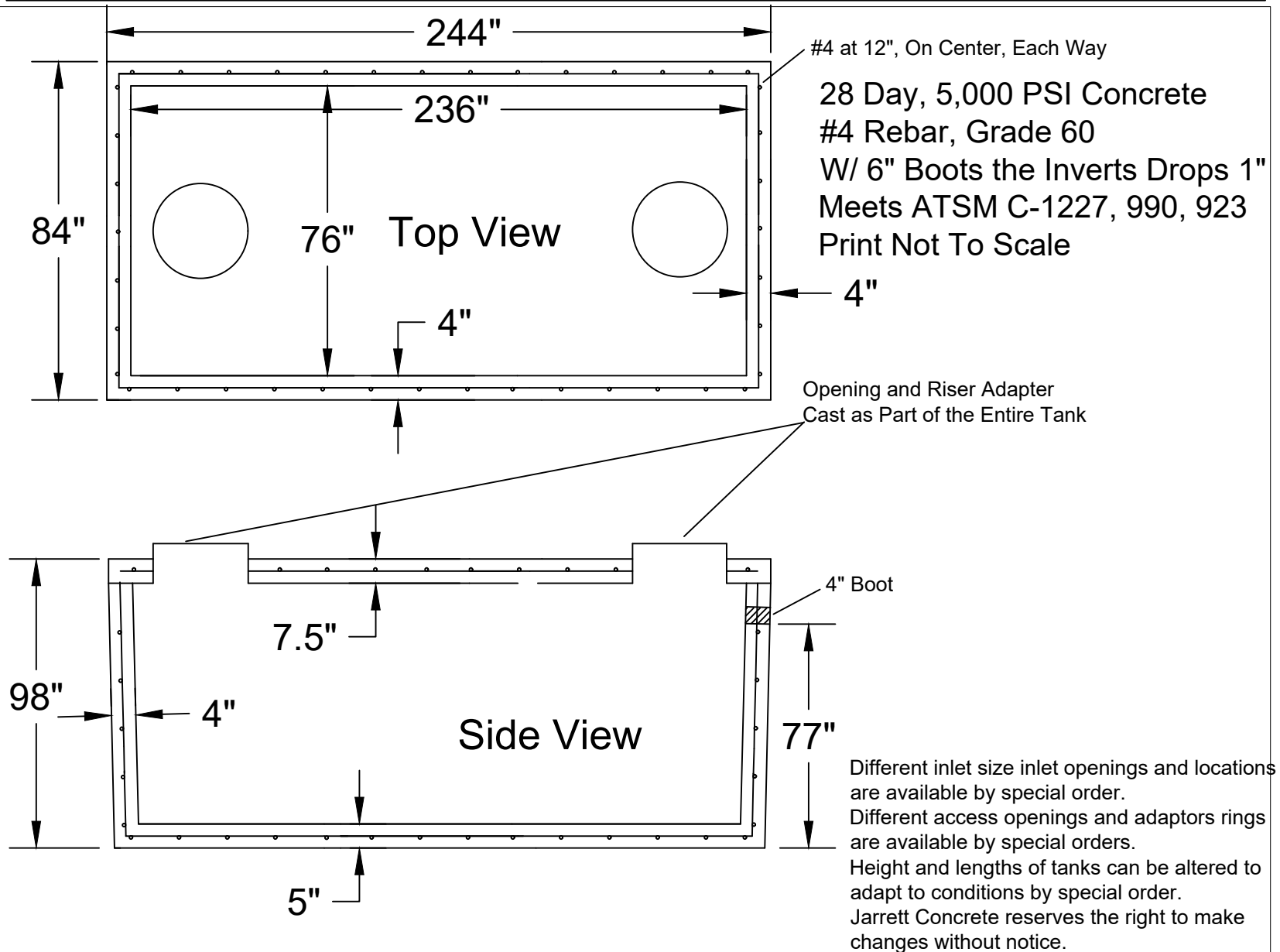

Jarrett Concrete Products 615-792-9332
2012 Hwy 12 South, Ashland City, TN 37015



S.T.E.P. Septic Tank 5000 Gallon

Date: 5-30-2018

Drawn By: L.Owen

Weight: 40,414 lbs

