

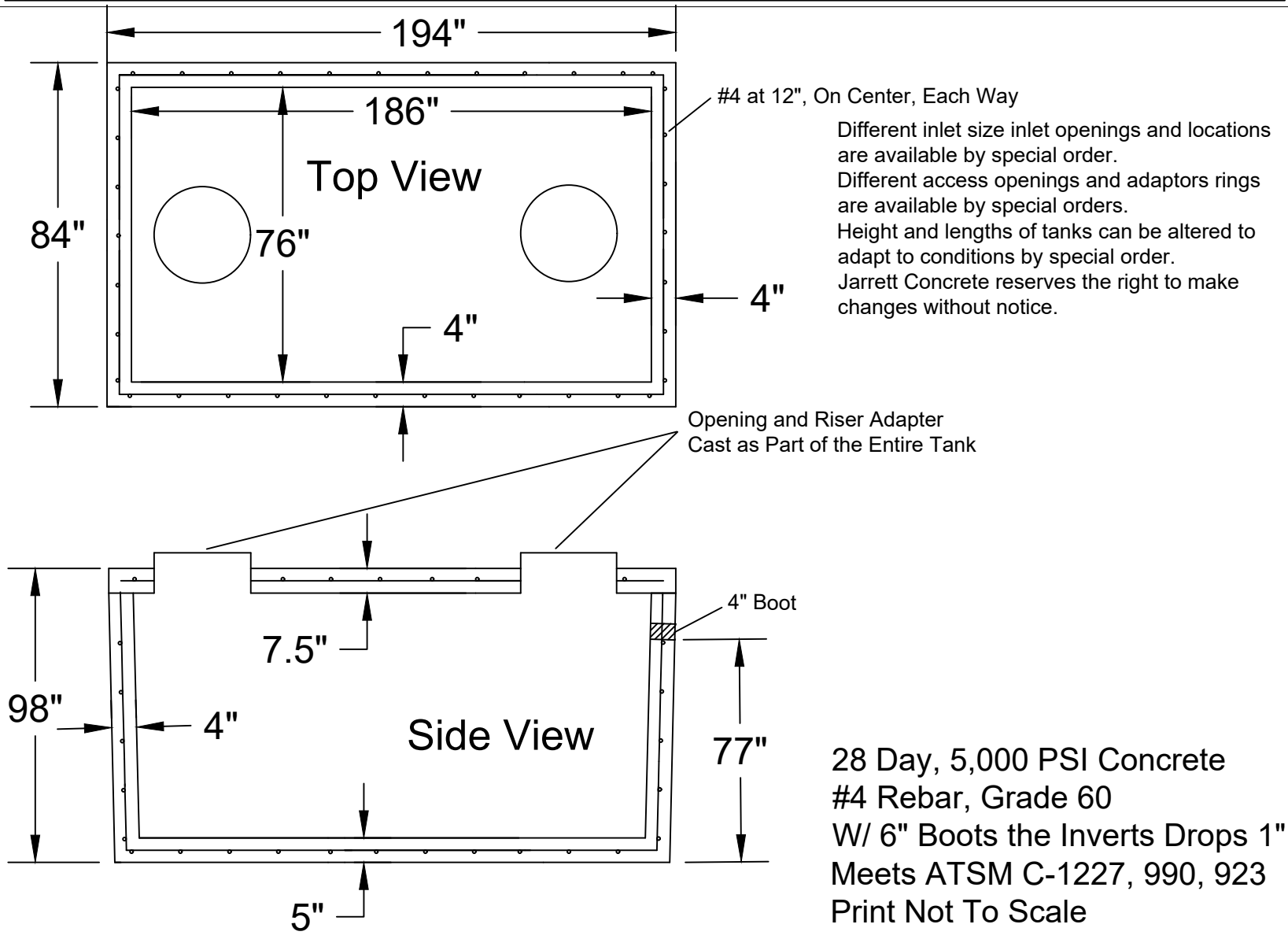

Jarrett Concrete Products 615-792-9332
 2012 Hwy 12 South, Ashland City, TN 37015



S.T.E.P. Septic Tank 4000 Gallon		
Date: 5-30-2018	Drawn By: L.Owen	Weight: 33,039 lbs

