

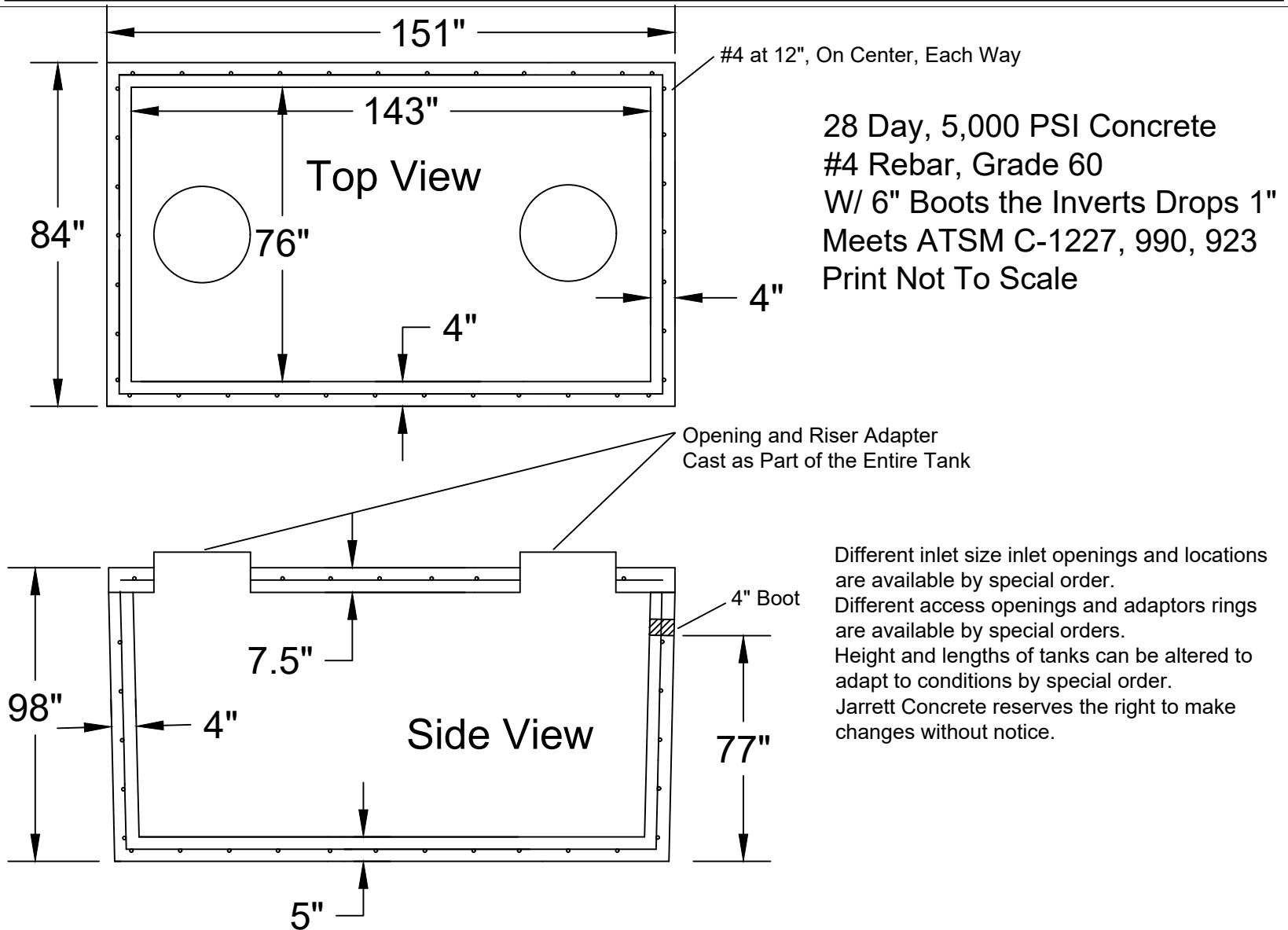

**Jarrett Concrete Products** 615-792-9332  
2012 Hwy 12 South, Ashland City, TN 37015



<b>S.T.E.P. Septic Tank 3000 Gallon</b>		
Date: 5-30-2018	Drawn By: L.Owen	Weight: 26,696 lbs

