

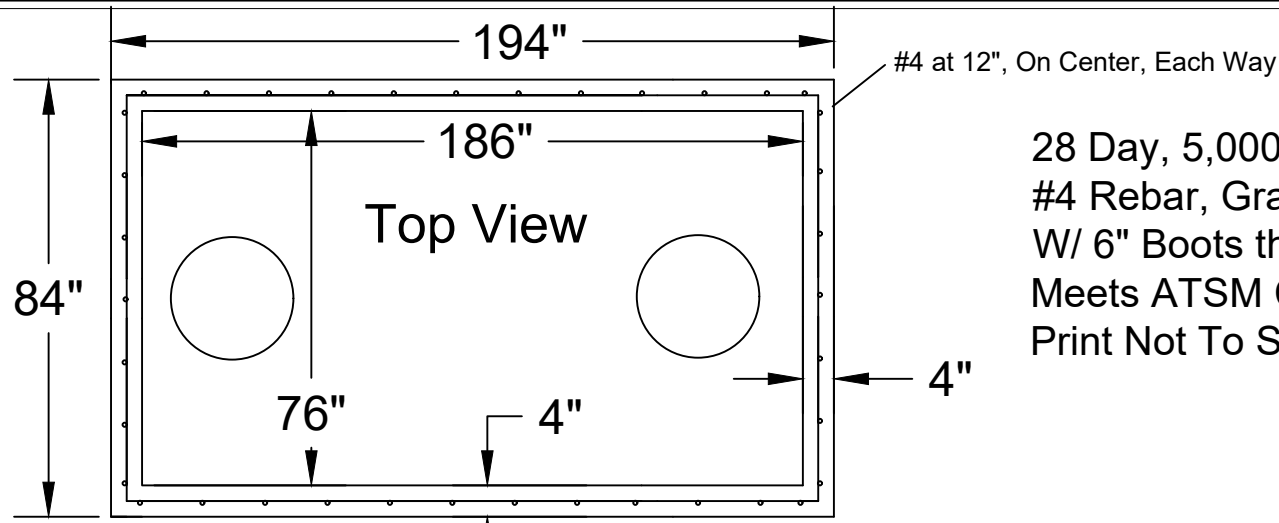

Jarrett Concrete Products 615-792-9332
2012 Hwy 12 South, Ashland City, TN 37015



28 Day, 5,000 PSI Concrete
#4 Rebar, Grade 60
W/ 6" Boots the Inverts Drops 1"
Meets ATSM C-1227, 990, 923
Print Not To Scale

Opening and Riser Adapter
Cast as Part of the Entire Tank

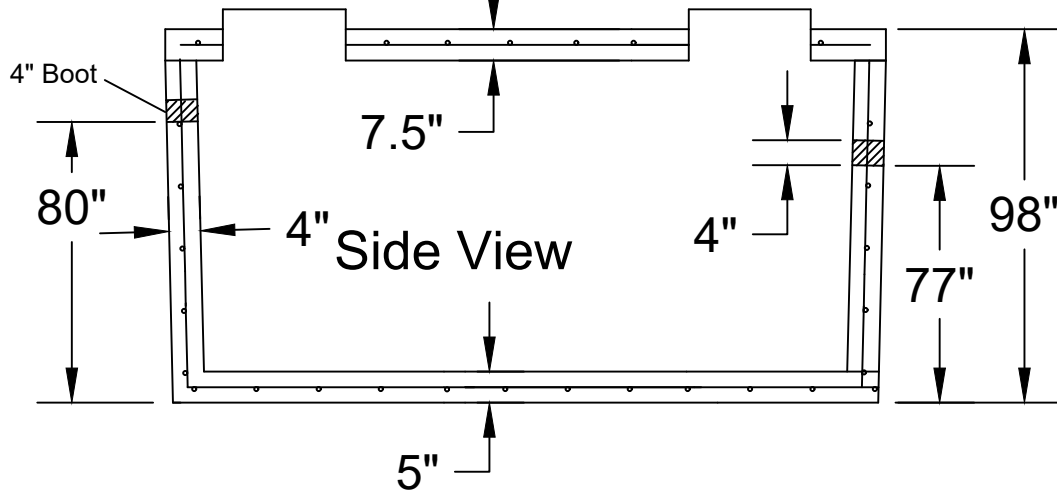

Different inlet size inlet openings and locations are available by special order.
Different access openings and adaptors rings are available by special orders.
Height and lengths of tanks can be altered to adapt to conditions by special order.
Jarrett Concrete reserves the right to make changes without notice.

S.T.E.G. Septic Tank 4000 Gallon

Date: 5-30-2018

Drawn By: L.Owen

Weight: 33,039 lbs

