

**JARRETT**

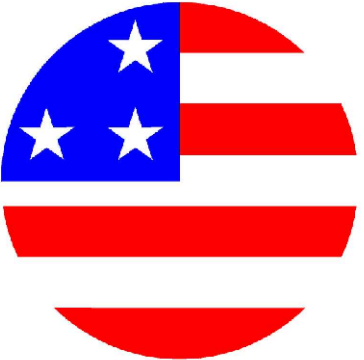

**CONCRETE**

**Jarrett Concrete Products 615-792-9332**  
2012 Hwy 12 South, Ashland City, TN 37015

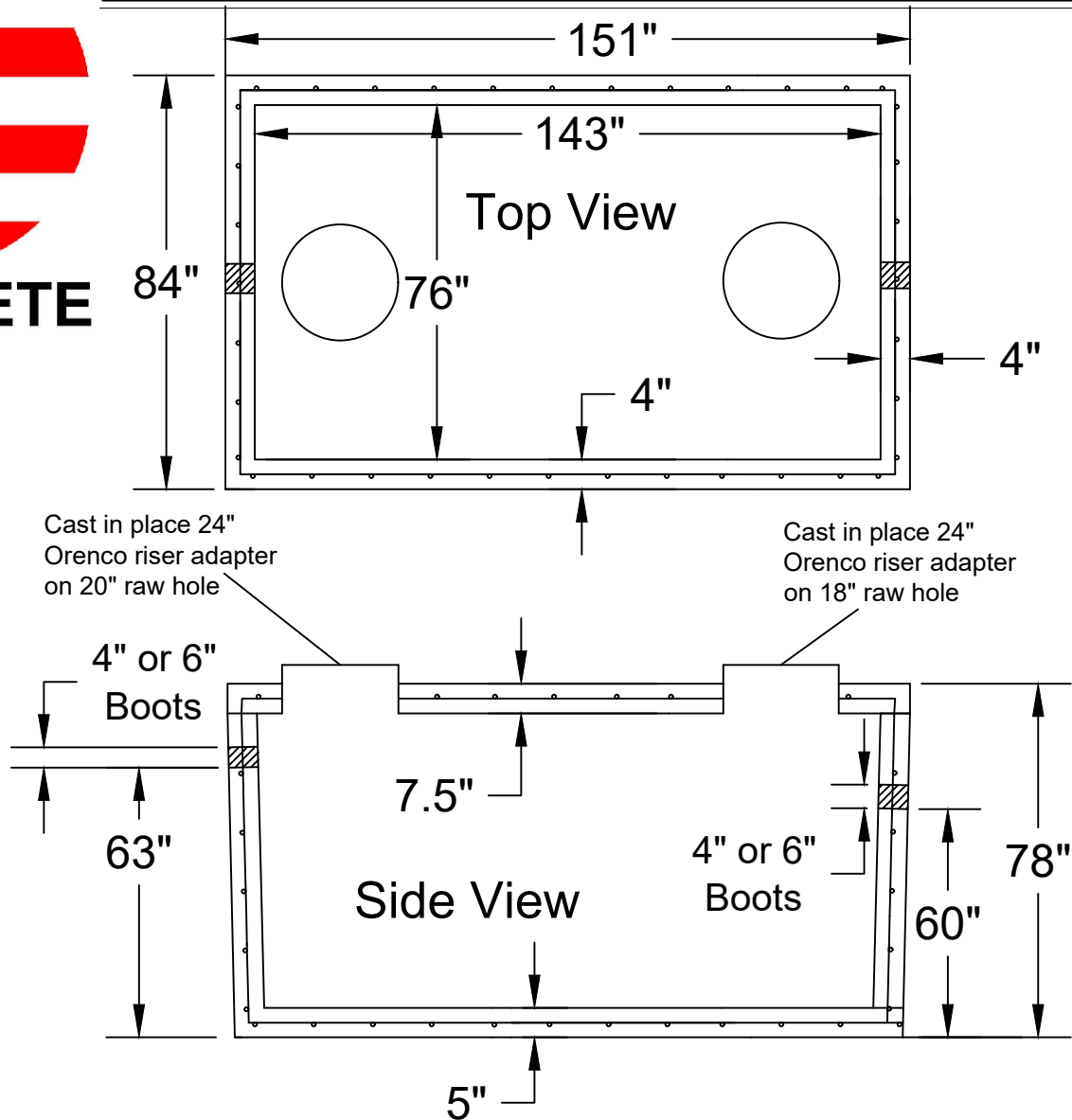

28 Day, 5,000 PSI Concrete  
#4 Rebar @12"o.c./e.w. Grade 60  
W/ 6" Boots the Inverts Drops 1"  
Meets ATSM C-1227, 990, 923  
Monolithic Tank Design  
"Top Tight" Patent Pending  
H-20 Traffic Rated  
Print Not To Scale

ALL TANKS SOLD BY JCP NEEDS TO BE WATER TESTED WITHIN FIVE BUSINESS DAYS FROM THE TIME WE SET THE TANKS. IF THE TANKS IS NOT TESTED WITHIN FIVE BUSNISS DAYS, IT IS ASSUMED YOU HAVE OPTED FOR A VACUUM TEST AT YOUR EXPENSE. IT IS THE CUSTOMER'S RESPONSIBILITY TO CORDINATE AND SCHEDULE THE WATER TEST WITH THE LOCAL INSPECTOR.

Different inlet size inlet openings and locations are available by special order.  
Different access openings and adaptors rings are available by special orders.  
Height and lengths of tanks can be altered to adapt to conditions by special order.  
Jarrett Concrete reserves the right to make changes without notice.



**S.T.E.G. Septic Tank 2500 Gallon**

Date: 8-20-2019

Drawn By: L.Owen

Weight: 23,139 lbs

