

JARRETT

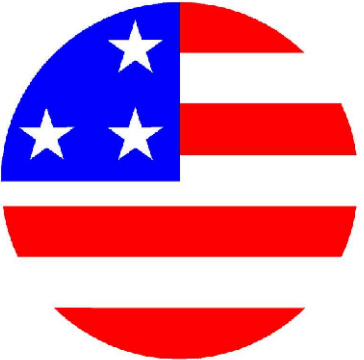

CONCRETE

Jarrett Concrete Products 615-792-9332
2012 Hwy 12 South, Ashland City, TN 37015

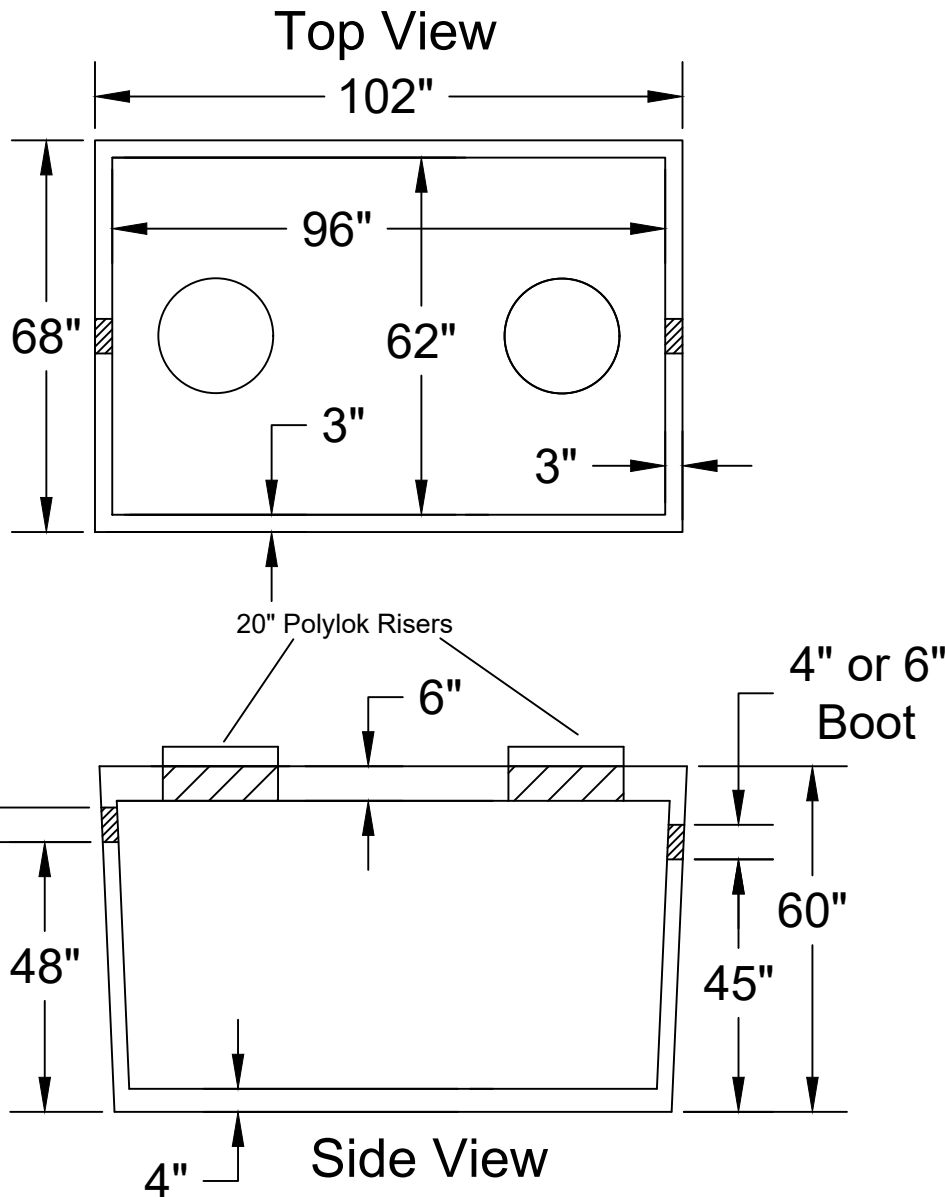

28 Day, 5,000 PSI Concrete
#4 Rebar @12"o.c./e.w. Grade 60
W/ 6" Boots the Inverts Drops 1"
Meets ATSM C-1227, 990, 923
Monolithic Tank Design
"Top Tight" Patented
H-20 Traffic Rated

ALL TANKS SOLD BY JCP MUST BE WATER TESTED WITHIN FIVE BUSINESS DAYS FROM THE TIME WE SET THE TANKS. IF THE TANKS IS NOT TESTED WITHIN FIVE BUSINESS DAYS, IT IS ASSUMED YOU HAVE OPTED FOR A VACUUM TEST AT YOUR EXPENSE. IT IS THE CUSTOMER'S RESPONSIBILITY TO COORDINATE AND SCHEDULE THE WATER TEST WITH THE LOCAL INSPECTOR.



Pump Tank 1000 Gallon

Date: 7-27-2021

Drawn By: L.Owen

Weight: 9,577 lbs

