

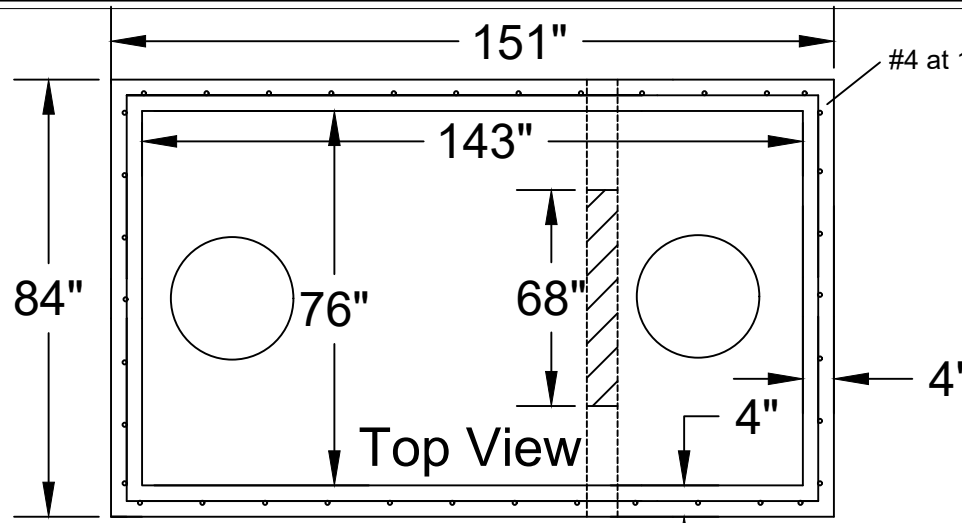

Jarrett Concrete Products 615-792-9332
 2012 Hwy 12 South, Ashland City, TN 37015



#4 at 12", On Center, Each Way

Different inlet size inlet openings and locations are available by special order.
 Different access openings and adaptors rings are available by special orders.
 Height and lengths of tanks can be altered to adapt to conditions by special order.
 Jarrett Concrete reserves the right to make changes without notice.

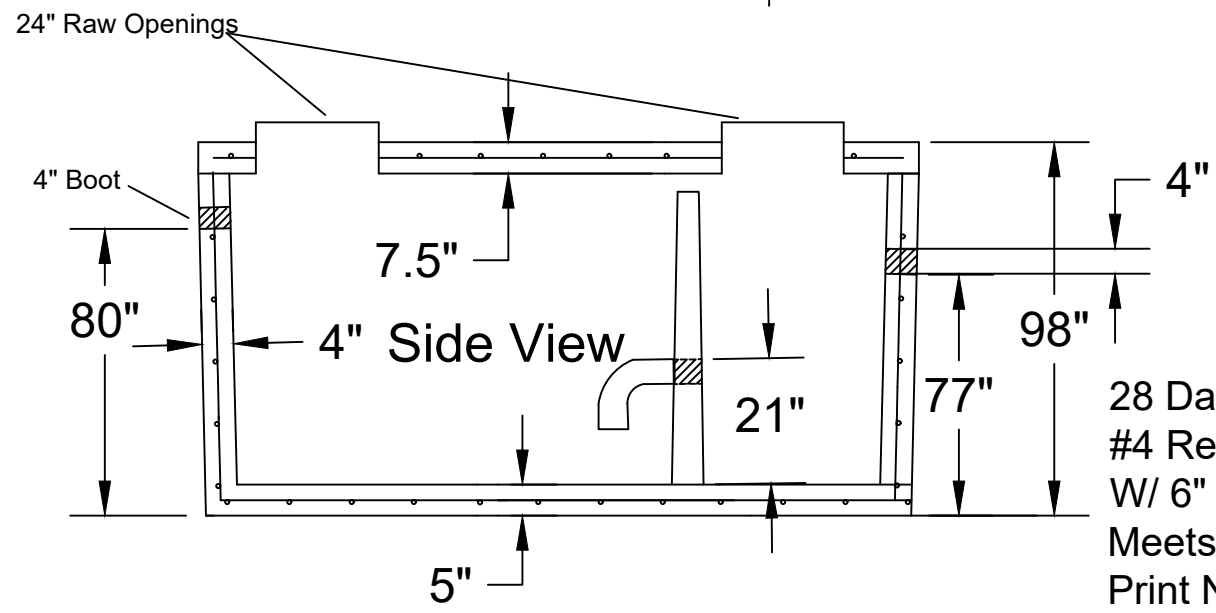

28 Day, 5,000 PSI Concrete
 #4 Rebar, Grade 60
 W/ 6" Boots the Inverts Drops 1"
 Meets ATSM C-1227, 990, 923
 Print Not To Scale

Grease Trap 3000 Gallon		
Date: 5-1-2018	Drawn By: L.Owen	Weight: 29,674 lbs

