

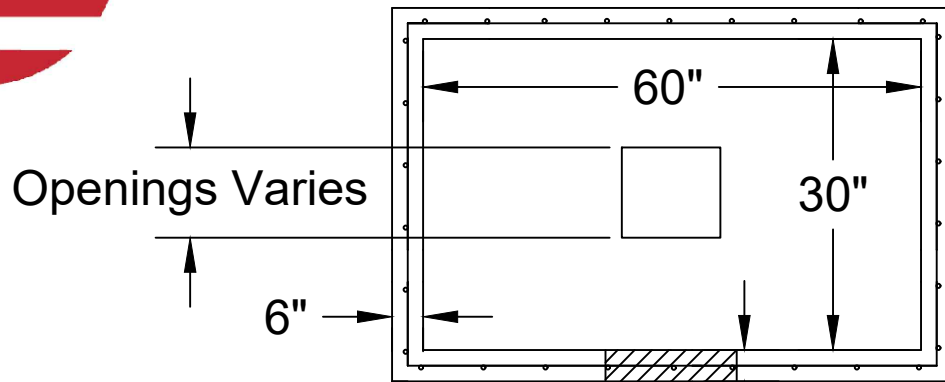

Jarrett Concrete Products 615-792-9332
2012 Hwy 12 South, Ashland City, TN 37015

Top View



28 Day, 5,000 PSI Concrete
#3 Rebar, Grade 60
#3 Rebar at 12" Centers
Meets ASTM- C-913
Print Not To Scale

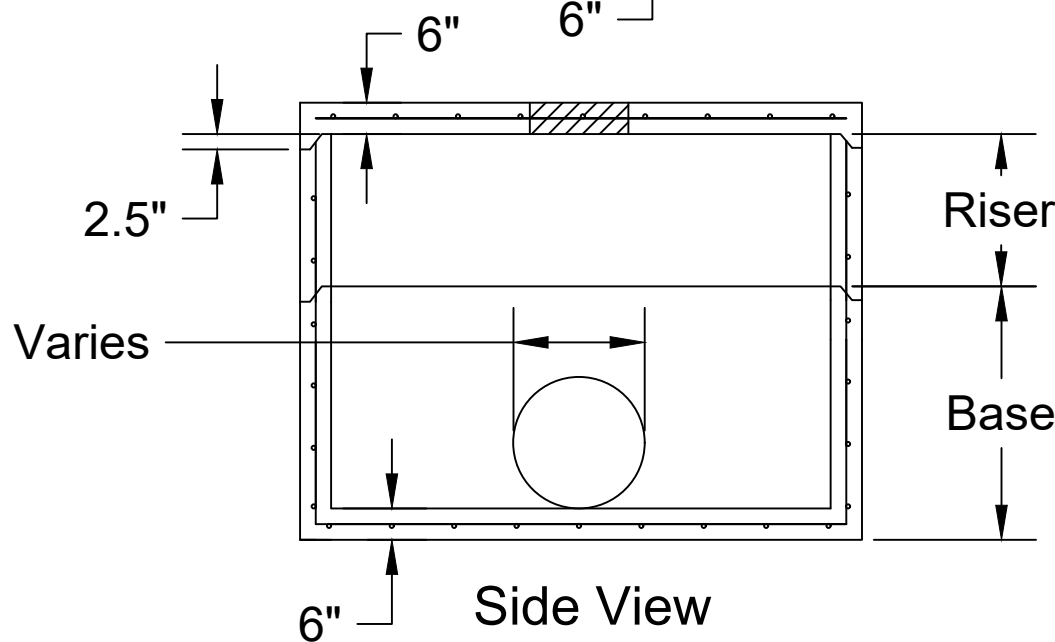

30" x 60" Curb Inlet / Catch Basin / Area Drain

Date: 5-4-2018

Drawn By: L.Owen

Weight: Up To 9,000 lbs

