

JARRETT

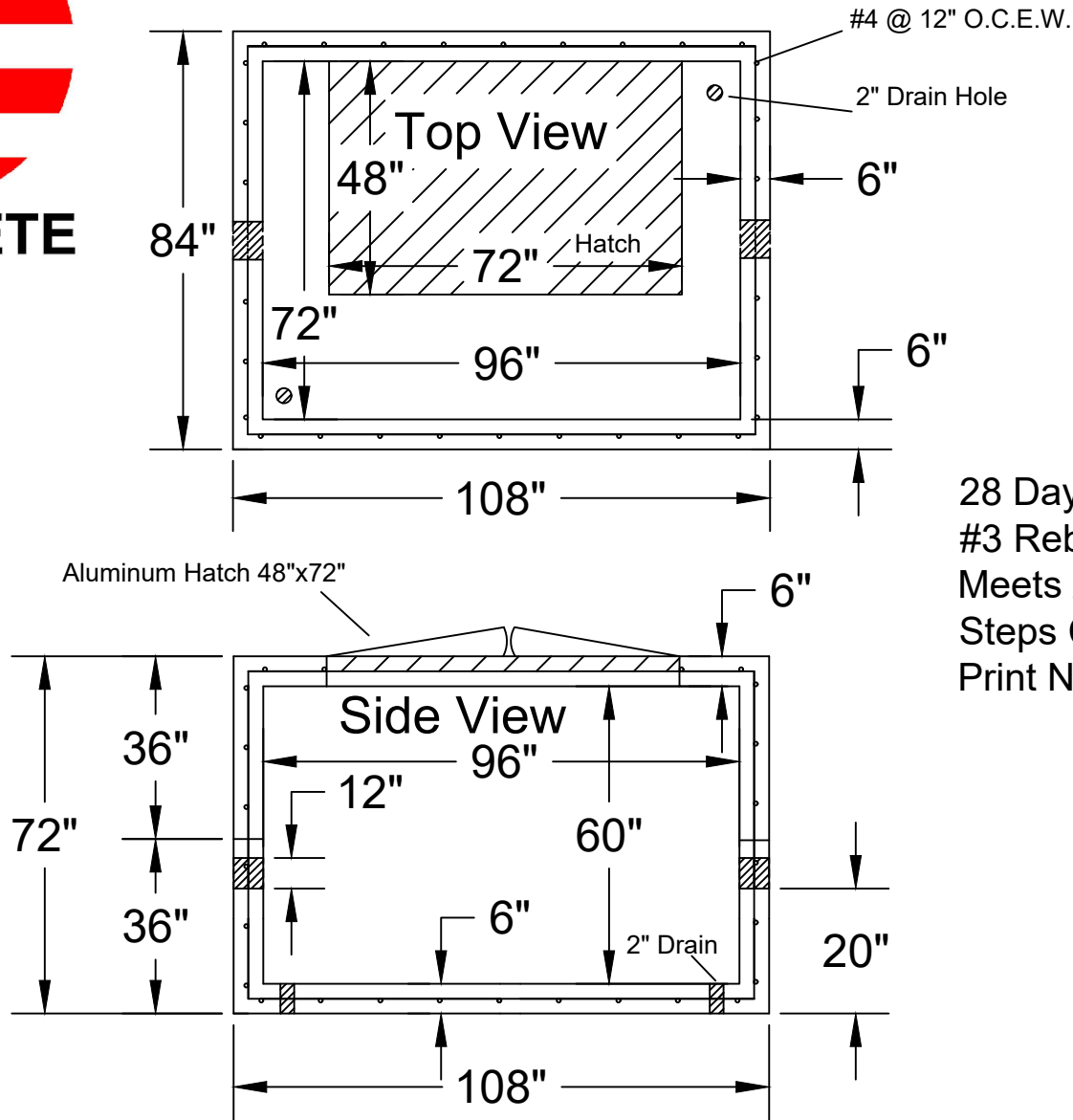

CONCRETE

Jarrett Concrete Products 615-792-9332
2012 Hwy 12 South, Ashland City, TN 37015



28 Day, 5,000 PSI Concrete
#3 Rebar, Grade 60
Meets ATSM C923 & C990
Steps Centered to Hatch
Print Not To Scale



8' x 6' Metro Meter Vault w/ Drains

Date: 8-12-2019

Drawn By: L.Owen

Weight: 20,281 lbs