

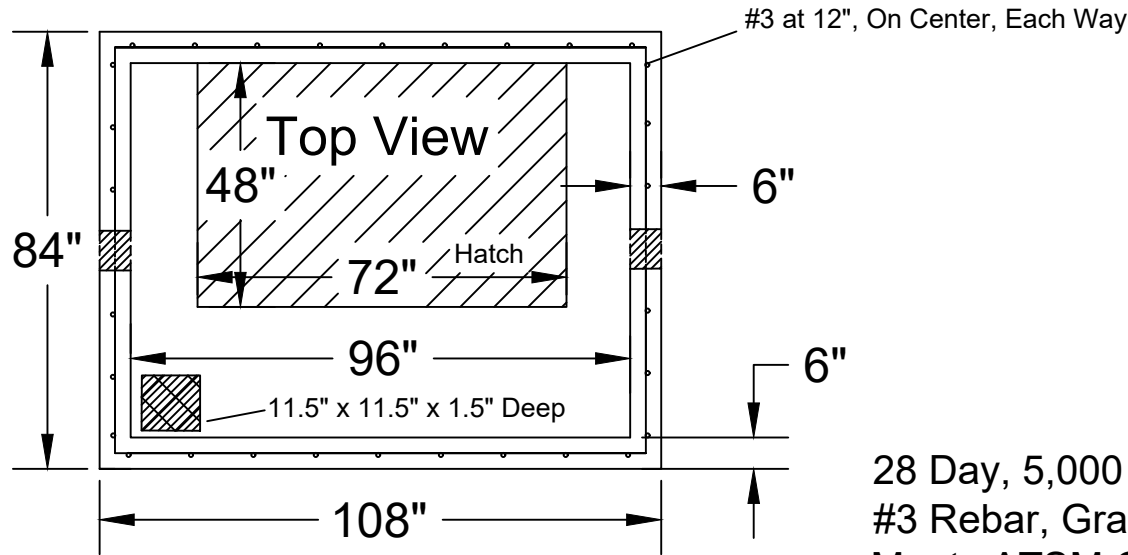

Jarrett Concrete Products 615-792-9332
2012 Hwy 12 South, Ashland City, TN 37015

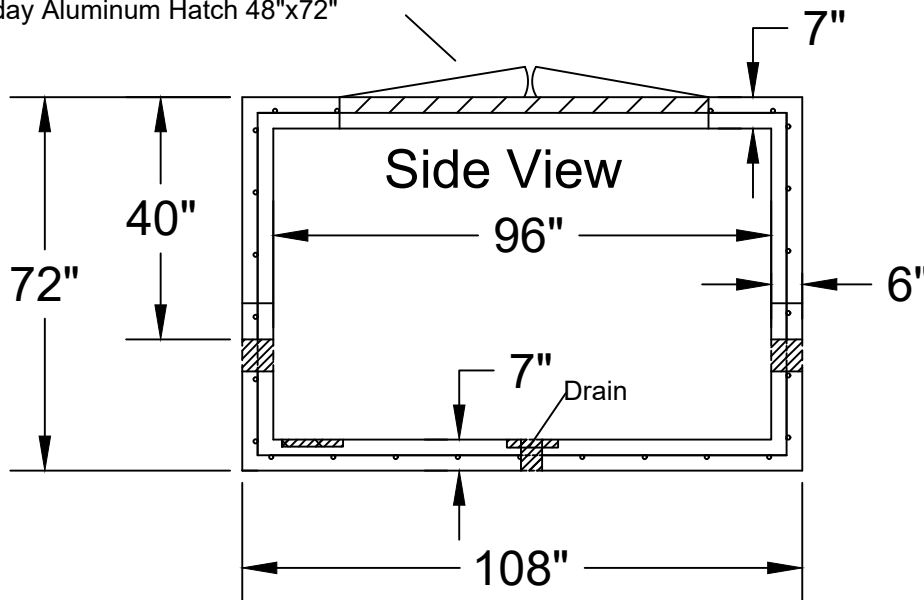

Halliday Aluminum Hatch 48"x72"



28 Day, 5,000 PSI Concrete
#3 Rebar, Grade 60
Meets ATSM C923 & C990
4" D.I.P - 10" D.I.P.
Steps Centered to Hatch
Print Not To Scale

8' x 6' Fire Service Backflow - 8 inch City of Hendersonville

Date: 4-20-2018

Drawn By: L.Owen

Weight: 18,000 lbs

