

JARRETT

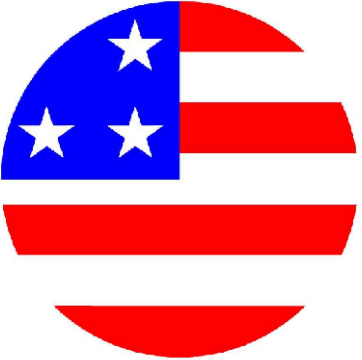

CONCRETE

Jarrett Concrete Products 615-792-9332
2012 Hwy 12 South, Ashland City, TN 37015

28 Day, 5,000 PSI Concrete
#3 Rebar on 12" Centers
Print Not To Scale

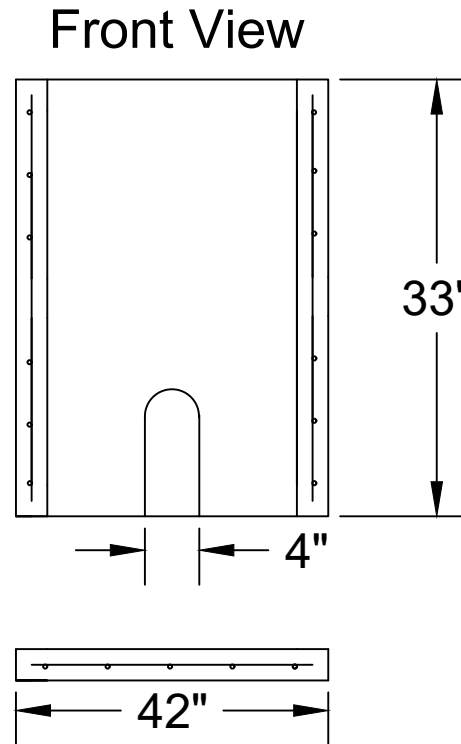
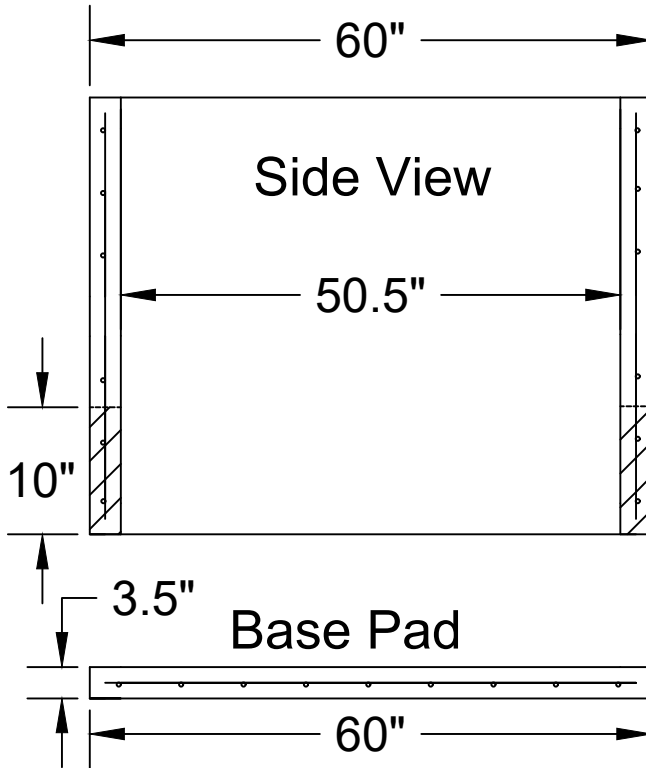
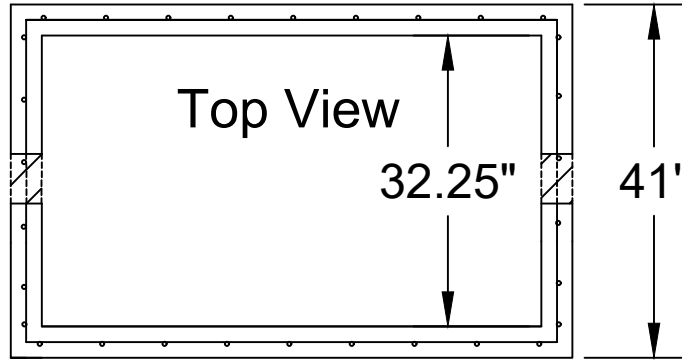

3" Meter Box

Date: 8-8-2019

Drawn By: L.Owen

Weight: 2,247 lbs

