

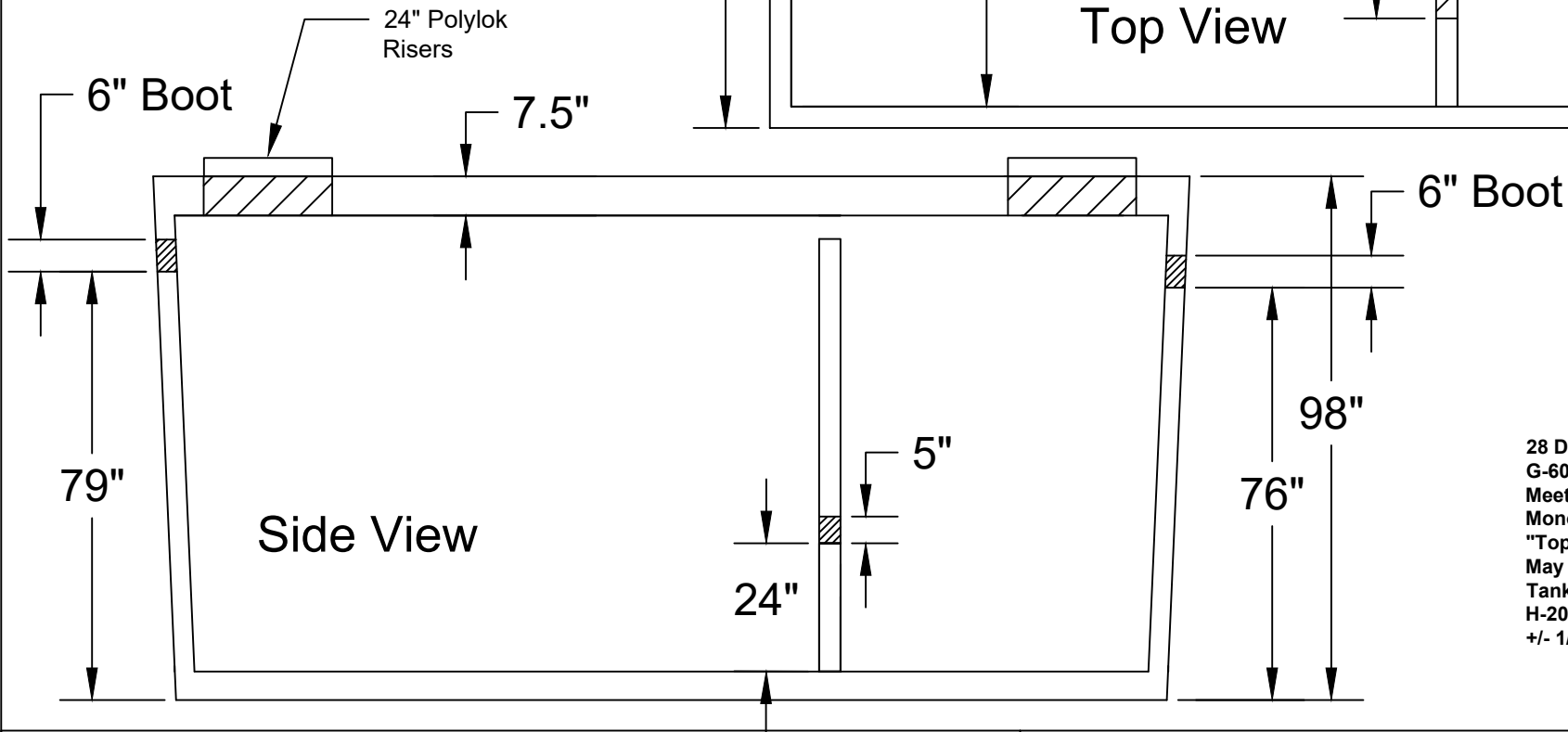

**Jarrett Concrete Products** 615-792-9332  
 2012 Hwy 12 South, Ashland City, TN 37015

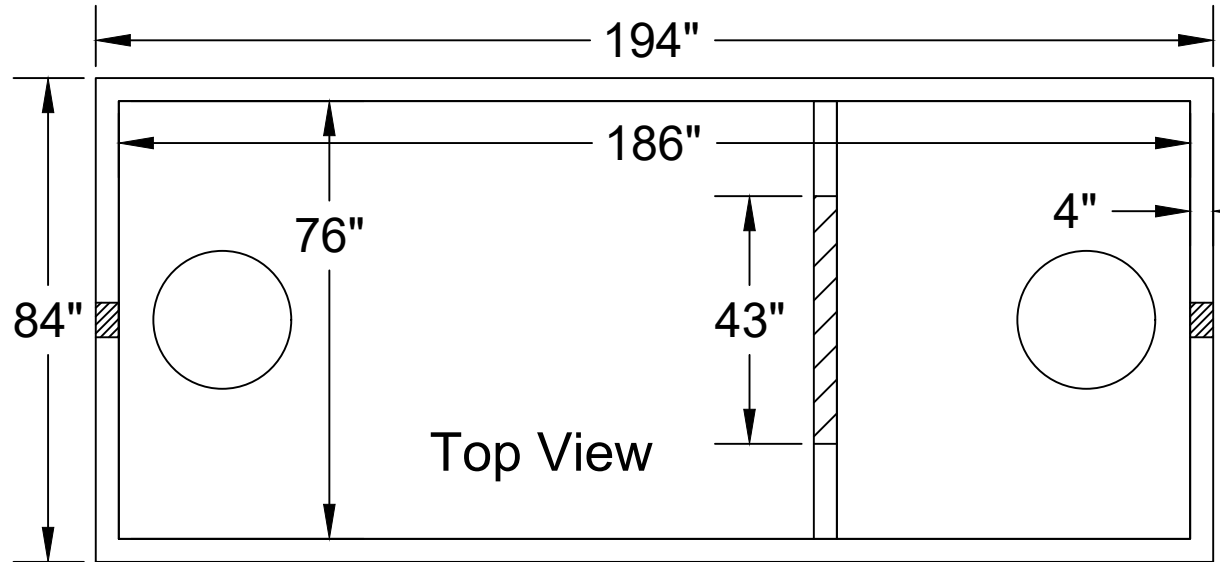

28 Day, 5,000 PSI Concrete  
 G-60 #4 Rebar @ 12" o.c.e.w.  
 Meets ASTM C-1227, 990, 923  
 Monolithic Tank Design  
 "Top Tight" Patented  
 May contain fiber in mix design  
 Tank may be epoxy coated  
 H-20 Traffic Rated  
 +/- 1/2" Tolerance

**Septic Tank 4000 Gallon (6" Boots)**

Date: 9-29-2023 Drawn By: L.Owen Weight: 35,510 lbs

TANKS SOLD BY JCP MUST BE WATER TESTED WITHIN 5 BUSINESS DAYS FROM THE TIME WE SET THE TANK. IF THE TANK IS NOT TESTED WITHIN 5 BUSINESS DAYS, IT IS ASSUMED YOU HAVE OPTED FOR A VACUUM TEST AT YOUR EXPENSE. IT'S THE CUSTOMER'S RESPONSIBILITY TO SCHEDULE WATER TEST WITH LOCAL INSPECTOR. DO NOT BACKFILL TANK UNTIL CLEARED BY INSPECTOR.