

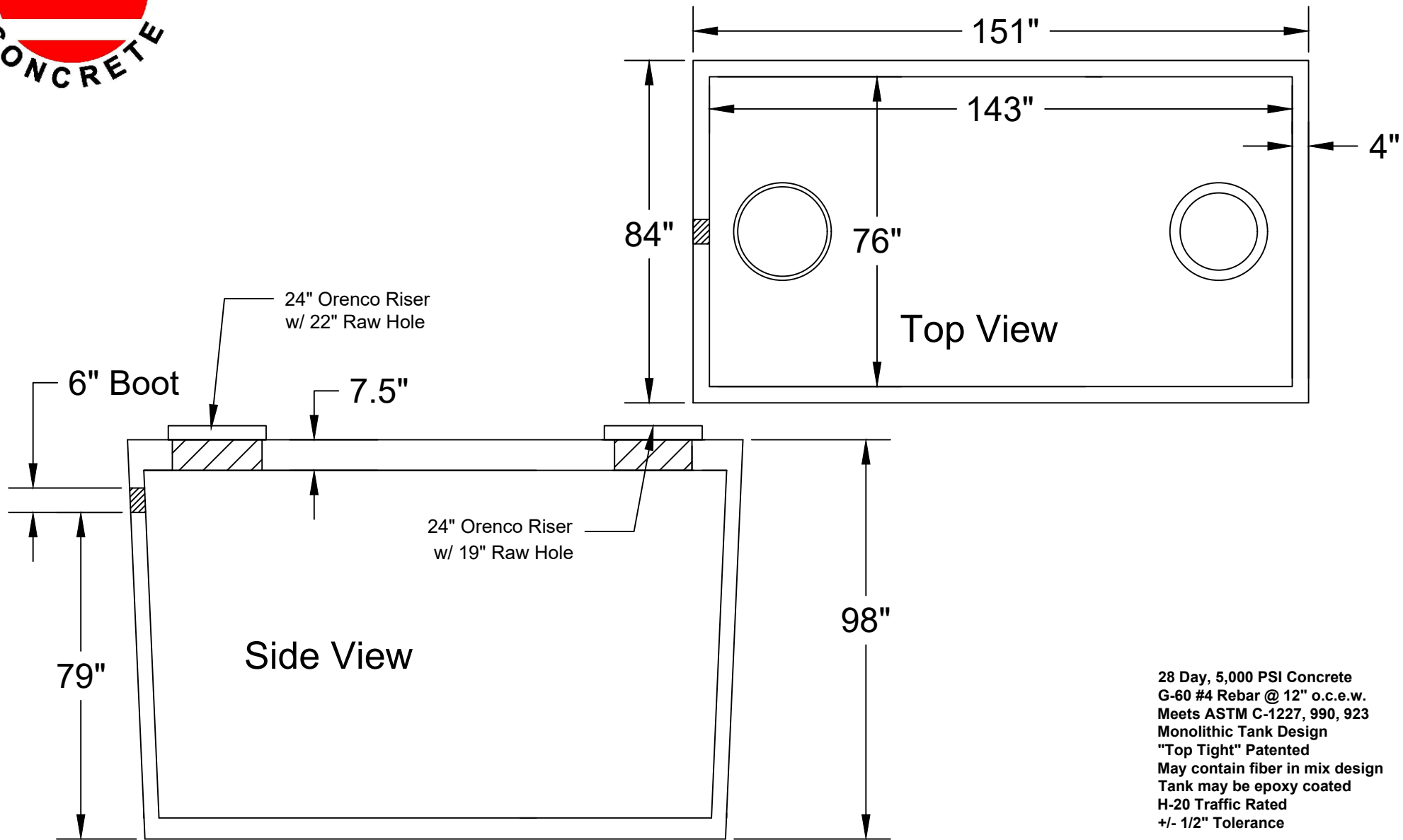

**Jarrett Concrete Products** 615-792-9332  
2012 Hwy 12 South, Ashland City, TN 37015



28 Day, 5,000 PSI Concrete  
G-60 #4 Rebar @ 12" o.c.e.w.  
Meets ASTM C-1227, 990, 923  
Monolithic Tank Design  
"Top Tight" Patented  
May contain fiber in mix design  
Tank may be epoxy coated  
H-20 Traffic Rated  
+/- 1/2" Tolerance

**S.T.E.P. Septic Tank 3000 Gallon (6" Boot)**

TANKS SOLD BY JCP MUST BE WATER TESTED WITHIN 5 BUSINESS DAYS FROM THE TIME WE SET THE TANK. IF THE TANK IS NOT TESTED WITHIN 5 BUSINESS DAYS, IT IS ASSUMED YOU HAVE OPTED FOR A VACUUM TEST AT YOUR EXPENSE. IT'S THE CUSTOMER'S RESPONSIBILITY TO SCHEDULE WATER TEST WITH LOCAL INSPECTOR. DO NOT BACKFILL TANK UNTIL CLEARED BY INSPECTOR.

Date: 9-27-2023

Drawn By: L.Owen

Weight: 26,234 lbs