

JARRETT

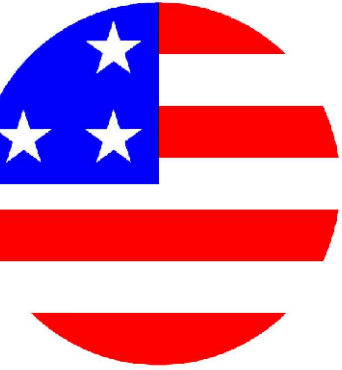

CONCRETE

Jarrett Concrete Products 615-792-9332
2012 Hwy 12 South, Ashland City, TN 37015

28 Day, 6,000 PSI Concrete, Type III Cement, Grade 60 Rebar
#5 Rebar 10" o.c.e.w. (Walls & Floor), #6 Rebar 8" o.c.e.w. (Top)
HS20-44 Rated, Pod Volume Varies Between 500-800 Cubic Feet
Steps Centered to Access Hole, Access Hole Not Needed in Every Pod
Bleed Hole Placement Based On Tailored Pod Configuration
Pods Can Be Made Any Size to Fit Your Parameters
Heaviest Pick Weight 33,000 lbs

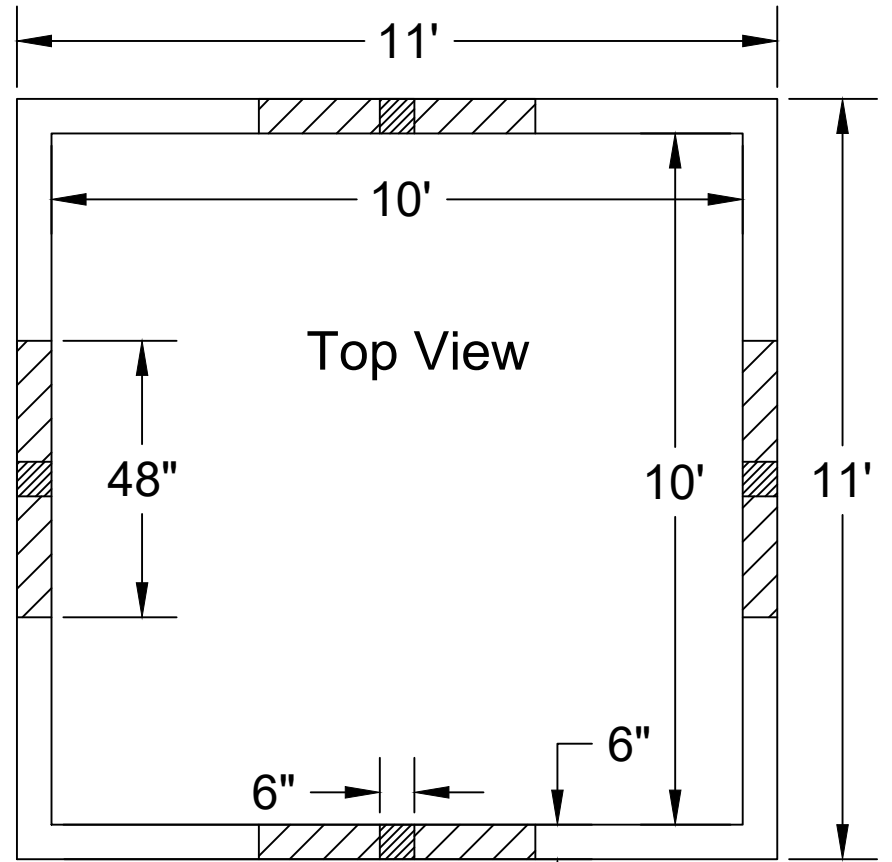
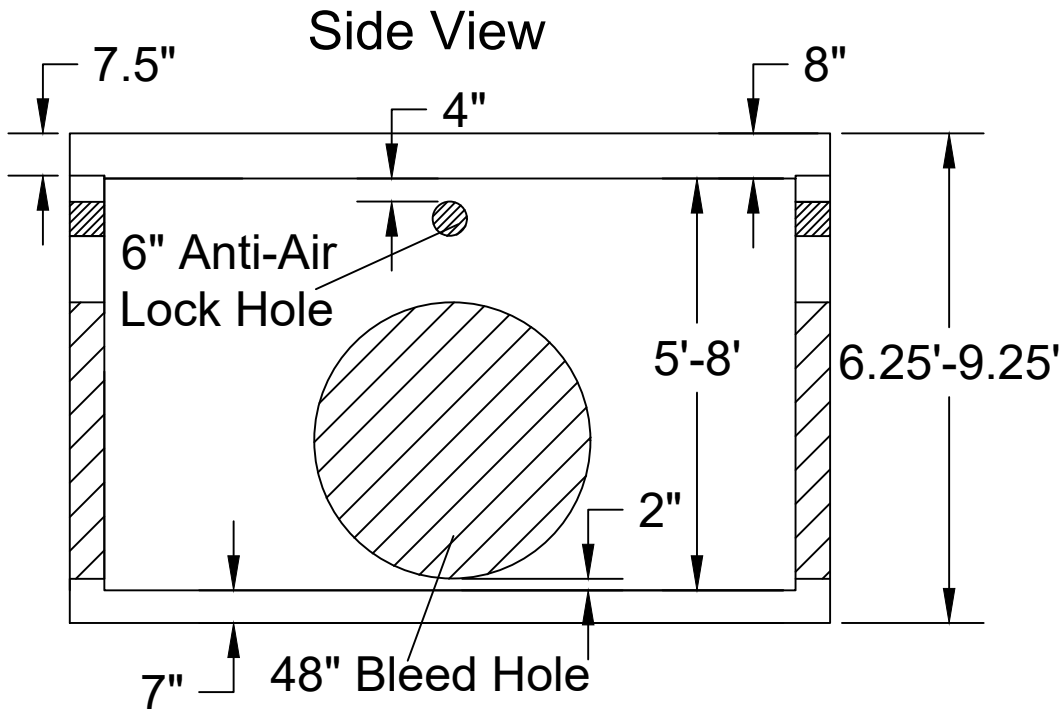

Rain Cave™ Underground Water Detention System RC1
Date: 10-12-2021 Drawn By: L.Owen Weight: 34,000-44,000 lbs