

**Jarrett Concrete Products** 615-792-9332  
2012 Hwy 12 South, Ashland City, TN 37015

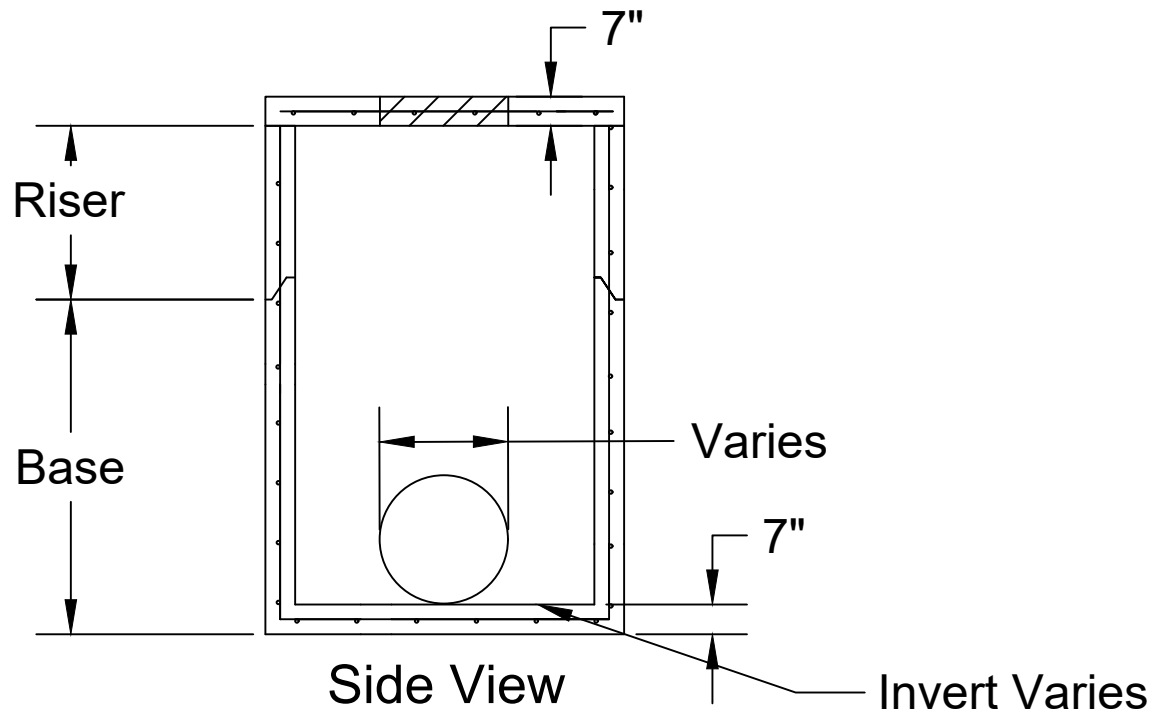

Top View

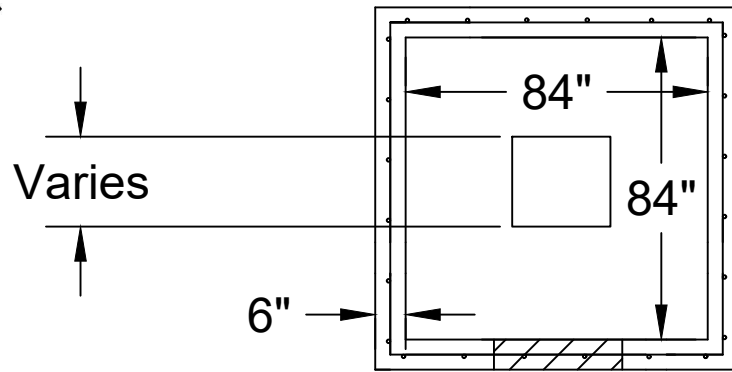

28 Day, 5,000 PSI Concrete  
G-60 #4 Rebar @ 12" o.c.e.w.  
Meets ASTM C-1227, 990, 923  
H-20 Traffic Rated  
+/- 1/2" Tolerance  
Print not to scale

**84" x 84" CI-CB-AD**

Date: 11-1-2023

Drawn By: L.Owen

Weight: Varies